

F34 Square Truss

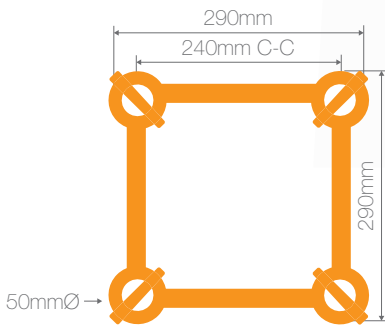
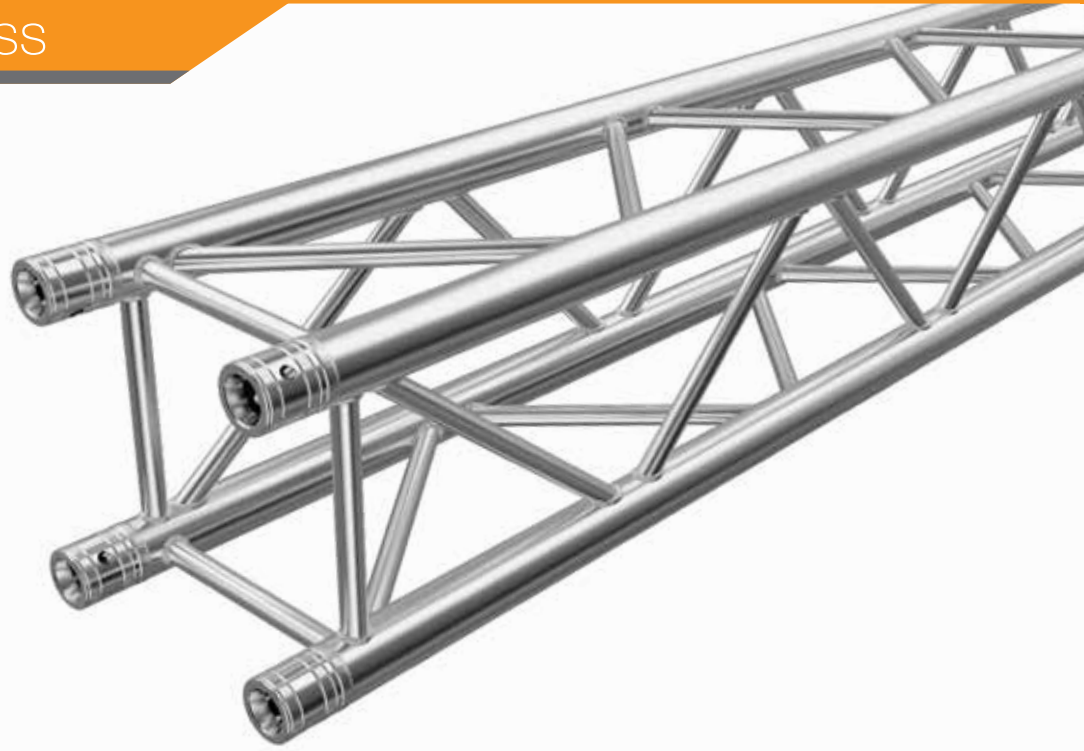

TECHNICAL SPECIFICATIONS

Chord Material	EN AW 6082 T6
Bracing Material	EN AW 6082 T6
End Socket Material	EN AW 6082 T6
Conical Spigot Material	EN AW 2011
Steel Pin Material	8.8 Grade
Chord Dimension	50mmØ x 2mm
Bracing Dimension	20mmØ x 2mm
Connectors Included	4 x Conical Spigot, Pins & R-Clips

LOAD TABLE

SPAN (m)	CPL (kg)	UDL (kg/m)
4.0	922	501
5.0	763	344
6.0	649	247
7.0	562	177
8.0	494	135
9.0	440	106
10.0	395	85
11.0	357	69
12.0	324	58
13.0	296	48
14.0	271	41
15.0	249	35
16.0	229	30
17.0	211	26
18.0	195	23

Load tables indicate load capacities only and need to be considered in the context of complete engineering certification available at dq.com.au

Full engineering report available upon request.



TÜV Nord Certified

This Global Truss product is fully certified by TÜV Nord and exceeds the applicable standards.



Global Truss ToolBox App

Load table(s) also available on the Global Truss ToolBox app. Download it now on your **iPhone** or **Android!**



DQ.COM.AU

DESIGN QUINTESSENCE | SYD (02) 9649 2266 • MELB (03) 9645 2266 • BRIS 07 3036 3666 • PER 0419 898 999 | EMAIL INFO@DQ.COM.AU

F34 Square Truss



LINEAR (2mm)

PRODUCT CODE		WEIGHT
GT F34L025	F34 Square 0.25m Linear Truss	4.1kg
GT F34L029	F34 Square 0.29m Linear Truss	4.2kg
GT F34L040	F34 Square 0.4m Linear Truss	4.6kg
GT F34L050	F34 Square 0.5m Linear Truss	5.2kg
GT F34L075	F34 Square 0.75m Linear Truss	6.1kg
GT F34L100	F34 Square 1.0m Linear Truss	7.4kg
GT F34L125	F34 Square 1.25m Linear Truss	8.6kg
GT F34L150	F34 Square 1.5m Linear Truss	9.7kg
GT F34L200	F34 Square 2.0m Linear Truss	11.9kg
GT F34L250	F34 Square 2.5m Linear Truss	14.1kg
GT F34L300	F34 Square 3.0m Linear Truss	16.4kg
GT F34L350	F34 Square 3.5m Linear Truss	18.6kg
GT F34L400	F34 Square 4.0m Linear Truss	20.8kg
GT F34L450	F34 Square 4.5m Linear Truss	23.4kg
GT F34L500	F34 Square 5.0m Linear Truss	25.4kg

Custom lengths can be manufactured to order.

RADIALS

PRODUCT CODE		RADIAL SIZE
GT F34R050-180	F34 Square 0.5mR (1.0mØ) 180° Radial Truss (2 parts to a Circle)	
GT F34R075-180	F34 Square 0.75mR (1.5mØ) 180° Radial Truss (2 parts to a Circle)	
GT F34R100-180	F34 Square 1.0mR (2.0mØ) 180° Radial Truss (2 Parts to a Circle)	
GT F34R100-90	F34 Square 1.0mR (2.0mØ) 90° Radial Truss (4 Parts to a Circle)	
GT F34R150-180	F34 Square 1.5mR (3.0mØ) 180° Radial Truss (2 Parts to a Circle)	
GT F34R150-45	F34 Square 1.5mR (3.0mØ) 45° Radial Truss (8 Parts to a Circle)	
GT F34R150-90	F34 Square 1.5mR (3.0mØ) 90° Radial Truss (4 Parts to a Circle)	
GT F34R200-45	F34 Square 2.0mR (4.0mØ) 45° Radial Truss (8 Parts to a Circle)	
GT F34R200-90	F34 Square 2.0mR (4.0mØ) 90° Radial Truss (4 Parts to a Circle)	
GT F34R250-45	F34 Square 2.5mR (5.0mØ) 45° Radial Truss (8 parts to a Circle)	
GT F34R250-90	F34 Square 2.5mR (5.0mØ) 90° Radial Truss (4 Parts to a Circle)	
GT F34R300-30	F34 Square 3.0mR (6.0mØ) 30° Radial Truss (12 Parts to a Circle)	
GT F34R300-45	F34 Square 3.0mR (6.0mØ) 45° Radial Truss (8 parts to a Circle)	
GT F34R300-60	F34 Square 3.0mR (6.0mØ) 60° Radial Truss (6 Parts to a Circle)	
GT F34R350-45	F34 Square 3.5mR (7.0mØ) 45° Radial Truss (8 Parts to a Circle)	
GT F34R400-45	F34 Square 4.0mR (8.0mØ) 45° Radial Truss (8 Parts to a Circle)	

Custom radials can be manufactured to order.



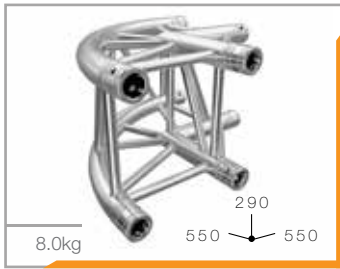

8.0kg

GT F34J21-S

2 Way 90° Soft Edge Corner

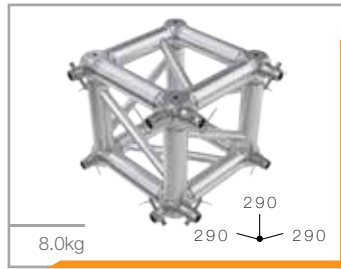

8.0kg

GT F34JBOX-M10/12

6 Way Cube Junction with 8 Cube Half-Spigots (M10/M12 Bolt) for 2 faces

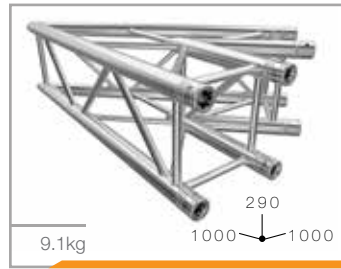

9.1kg

GT F34J19

2 Way 45° Corner

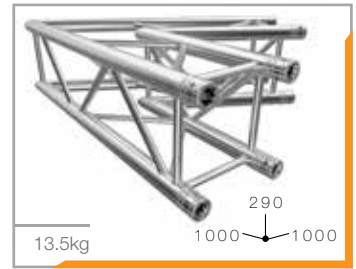

13.5kg

GT F34J20

2 Way 60° Corner



7.8kg

GT F34J21

2 Way 90° Corner



8.8kg

GT F34J22

2 Way 120° Corner



9.1kg

GT F34J23

2 Way 135° Corner



11.4kg

GT F34J30

3 Way 90° Corner to Vertical Junction

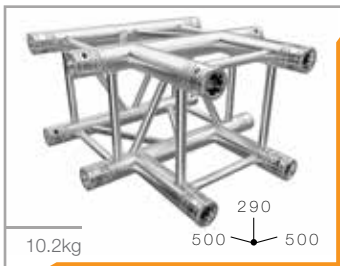

10.2kg

GT F34J35

3 Way T-Junction

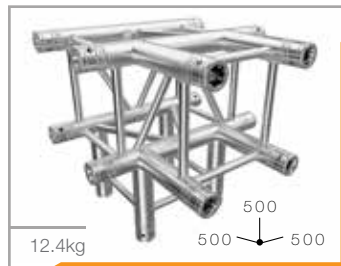

12.4kg

GT F34J40

4 Way T- to Vertical Junction (Up/Down)

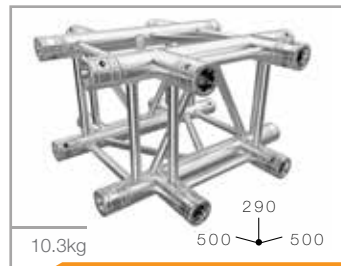

10.3kg

GT F34J41

4 Way X-Junction

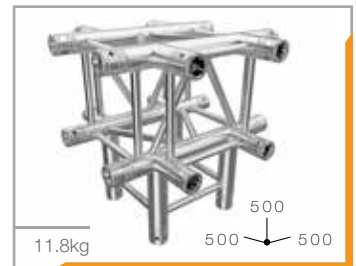

11.8kg

GT F34J55

5 Way X- to Vertical Junction



9.0kg

GT A-RIG-F34-LGR

F34 1mØ Truss Ring including 4 x Base Plate Half-Spigots (M12x60 Bolt), Pins & R-Clips

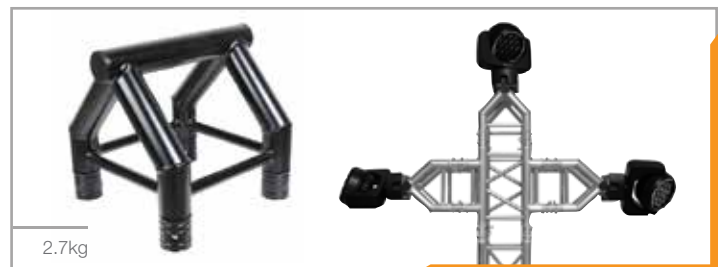

2.7kg

GT A-RIG-EBRF34-B

F34 Truss Bridge - Black



15.1kg

GT F34JV0-25

0-25° Variable Hinged Junction (with angle setting at 2.5° increments)



8.7kg

GT F33-34JV0-180

0-180° Variable Hinged Junction



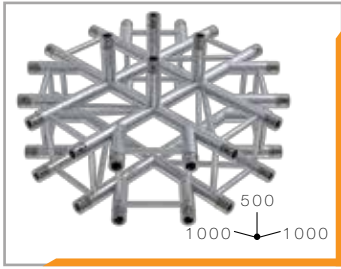

GT F34JS9

9 Way Junction

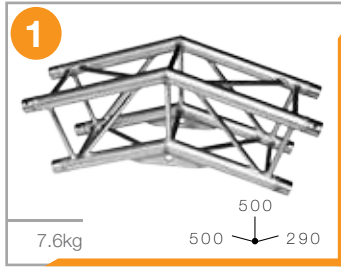

GT F34PJ144

Reinforced 144° Hoecker Roof Pitch Apex Junction

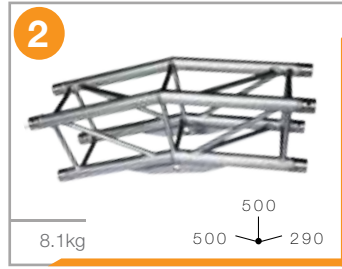

GT F34PJ162

Reinforced 162° Hoecker Roof Pitch Flat Top Junction

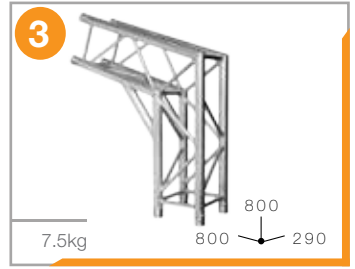

GT F34PJ108

Reinforced 108° Hoecker Roof Pitch Leg Junction

