

F42P FLAT TRUSS

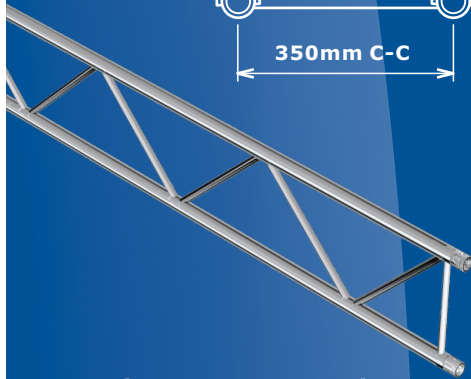

Linear Truss Lengths

CODE	LENGTH	WEIGHT
GT F42PL500	5.0m	11.5kg
GT F42PL450	4.5m	10.5kg
GT F42PL400	4.0m	9.5kg
GT F42PL350	3.5m	8.5kg
GT F42PL300	3.0m	7.5kg
GT F42PL250	2.5m	6.5kg
GT F42PL200	2.0m	5.5kg
GT F42PL150	1.5m	4.5kg
GT F42PL100	1.0m	3.5kg
GT F42PL050	0.5m	2.5kg

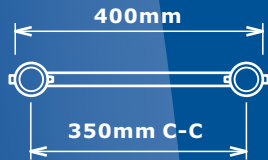
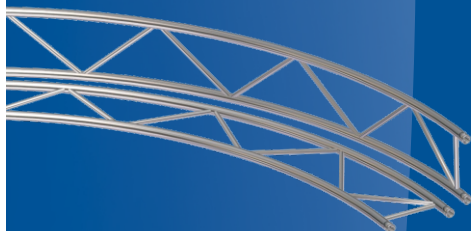

Radial Truss Available Sizes

CODE	RADIAL SIZE
GT F42PR050-180-H/V	0.5mR (1.0mØ) 180° H/V
GT F42PR075-180-H/V	0.75mR (1.5mØ) 180° H/V
GT F42PR100-180-H/V	1.0mR (2.0mØ) 180° H/V
GT F42PR100-90-H/V	1.0mR (2.0mØ) 90° H/V
GT F42PR150-90-H/V	1.5mR (3.0mØ) 90° H/V
GT F42PR200-90-H/V	2.0mR (4.0mØ) 90° H/V
GT F42PR250-90-H/V	2.5mR (5.0mØ) 90° H/V
GT F42PR300-60-H/V	3.0mR (6.0mØ) 60° H/V
GT F42PR350-45-H/V	3.5mR (7.0mØ) 45° H/V
GT F42PR400-45-H/V	4.0mR (8.0mØ) 45° H/V
GT F42PR450-45-H/V	4.5mR (9.0mØ) 45° H/V
GT F42PR500-30-H/V	5.0mR (10.0mØ) 30° H/V
GT F42PR550-30-H/V	5.5mR (11.0mØ) 30° H/V
GT F42PR600-30-H/V	6.0mR (12.0mØ) 30° H/V
GT F42PR650-30-H/V	6.5mR (13.0mØ) 30° H/V
GT F42PR700-30-H/V	7.0mR (14.0mØ) 30° H/V
GT F42PR750-30-H/V	7.5mR (15.0mØ) 30° H/V



Design Quintessence Pty Ltd

Unit 25 7-9 Percy Street Auburn NSW Australia
 Tel (02) 9649 2266
 Fax (02) 9649 2200
 email info@dq.com.au

GT F42PJ19-H
45° HORIZONTAL CORNER

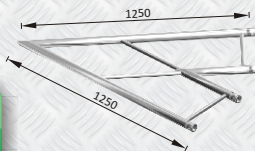

GT F42PJ19-V
45° VERTICAL CORNER

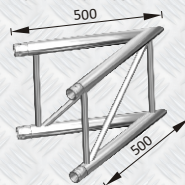

GT F42PJ20-H
60° HORIZONTAL CORNER

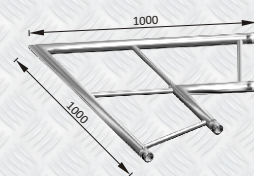

GT F42PJ20-V
60° VERTICAL CORNER



GT F42PJ21-H
90° HORIZONTAL CORNER

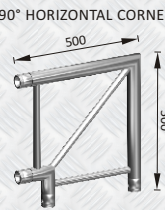

GT F42PJ21-V
90° VERTICAL CORNER



GT F42PJ22-H
120° HORIZONTAL CORNER

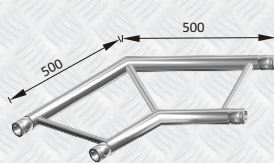

GT F42PJ22-V
120° VERTICAL CORNER

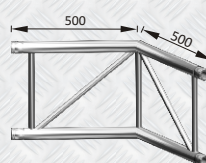

GT F42PJ23-H
135° HORIZONTAL CORNER

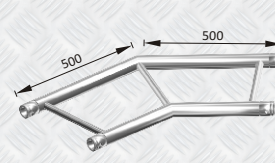

GT F42PJ23-V
135° VERTICAL CORNER

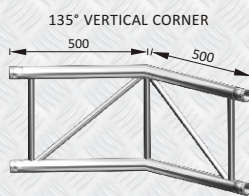

GT F42PJ31-H
90° CORNER TO VERTICAL JUNC (H)

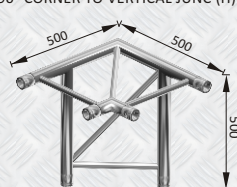

GT F42PJ31-V
90° CORNER TO VERTICAL JUNC (V)

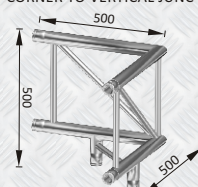

GT F42PJ36-H
HORIZONTAL 'T' JUNCTION

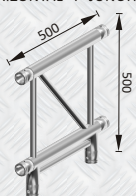

GT F42PJ36-V
VERTICAL 'T' JUNCTION

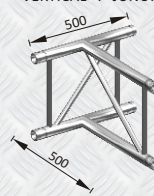

GT F42PJ41-H
HORIZONTAL 'X' JUNCTION

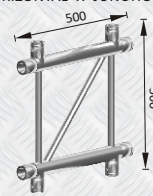

GT F42PJ41-V
VERTICAL 'X' JUNCTION

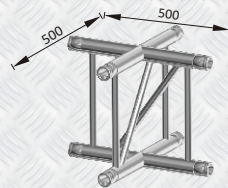

GT F42PJ42-V
4 WAY JUNCTION - VERTICAL

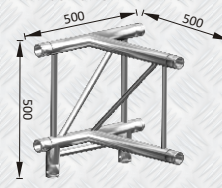

GT F42PJBOX
4 WAY UNIVERSAL JUNCTION



F42P CERTIFIED LOAD RATINGS**

SPAN	MAXIMUM CPL	MAX DIST LOAD
1m	1,104kg	1,101kg/m
2m	1,102kg	550kg/m
3m	718kg	367kg/m
4m	404kg	172kg/m
5m	211kg	70kg/m
6m	93kg	33kg/m

** NOTE: LOAD TABLES ARE AN EXCERPT ONLY FROM A COMPLETE STRUCTURAL CERTIFICATE AND MUST BE INTERPRETED IN CONTEXT WITH THE ENTIRE CERTIFICATE AND ANY CONDITIONS CONTAINED THEREIN. FOR FULL CERTIFICATES PLEASE VISIT OUR WEBSITE. GLOBAL TRUSS IS INDEPENDENTLY CERTIFIED AND THE LOAD RATINGS DO NOT APPLY TO OTHER BRANDS OF TRUSS. INTERCONNECTION BETWEEN GLOBAL TRUSS AND OTHER BRANDS VOIDS THE STRUCTURAL CERTIFICATION.