

HALF COUPLER 60 | 50 | 500KG

CODE 828



Dieser Coupler ist speziell für 60mm Gurtrohre entwickelt, wie sie z.B. als Züge im Theater vorkommen und kann bis zu 500kg Gewicht aufnehmen. Durch seine Breite bietet er wesentlich mehr Auflagefläche am Traversengurt und ist dadurch besser gegen ein ungewolltes Rutschen gesichert.

This coupler was specifically developed for 60mm main chords and can take loads of up to 500kg. It's increased width offers a substantially larger load bearing surface area.

Kompatibel | compatible
Breite | width
Zugbelastung | tensile load
Abgang | retaining screw

Verschluss | screw plug
Aluminium | aluminum
Geprüft nach | tested according

60 mm
50 mm
500 kg SWL
M10 Geräteschraube, Sprengring,
Unterlegscheibe
M10 screw, spring-lock, washer
M12 Flügelmutter | wing nut
6061 T6
DIN EN 13814:2004

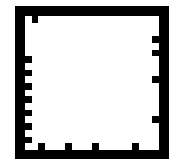
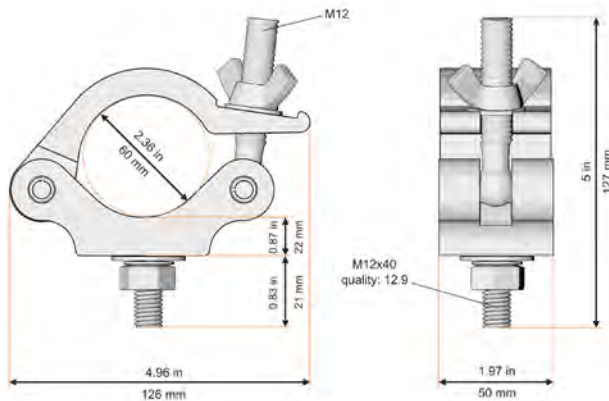

KOMPATIBILITÄT | COMPATIBILITY

60 mm Gurtrohr | 60mm main chord



F52 Folding



F54



F44



F44P



F34



F34P



F34PL



F34QX



F24



F43



F33



F33PL



M25AS



F23



F42



F32



F22



F31



F31PL