

DESIGN*it*

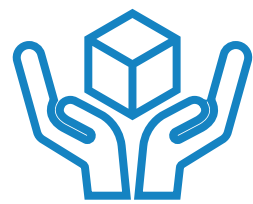

MAKE*it*



PROTECT*it*



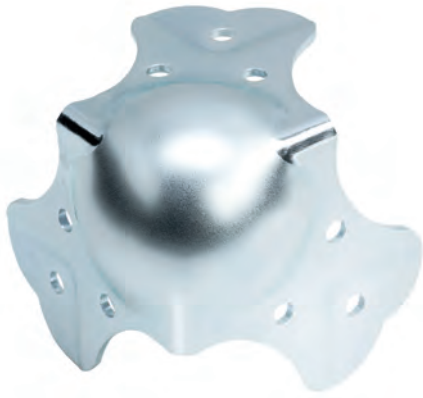

Our Adam Hall® hardware range offers a comprehensive selection of heavy duty case components that are developed in Germany for professional flight case manufacturers.



PLYWOOD CONSTRUCTION

Ovation Cases are constructed from Adam Hall's ply⁽²⁾, which is specifically engineered for high-performance heavy-duty road cases. Adam Hall plywood is made out of Scandinavian Birch layers glued together with DIN-certified (DIN EN 204) D4 graded glue for maximum stability and resistance to moisture exposure. The ply is also protected by ABS coating on both sides with one side being textured for a more professional unique look and feel.

EXTRUSIONS

Our Ovation Cases case frames are designed and built around a globally recognised, trusted and well-reputable brand, Adam Hall^(4,6).

As a pioneer of flight case components and over 40 years of experience and manufacturers of high-quality, robust case fittings, Adam Hall has developed into a global distributor with comprehensive solutions for the entertainment technology industry and all our hardware and materials are imported directly from Europe.

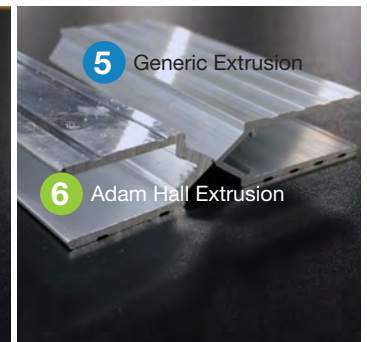
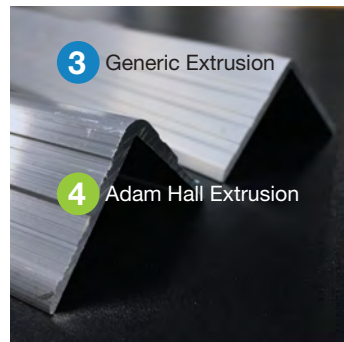

HARDWARE

The new case hardware from Adam Hall definitely make a big difference in both quality and aesthetics of the cases. There are so many versatile uses for all our road case hardware, much like the case frame materials, the case hardware are designed with heavy duty profiles for added durability to ensure longevity of the case build.

The hardware have an additional layer of sheet metal riveted into the main dish and are also designed with a rivet protection channel⁽⁷⁾, which means they have grooves around the rivets to protect the rivets from being damaged in transit.



HINGES

Ovation Cases benefit from a complete hinge functionality which includes, and not limited to, piano hinges, butterfly hinges and hinged lid stays. The new Adam Hall hinges have a thicker profile and are a lot stronger than most road case hardware. They also align perfectly with the grooves on the lid stays.

The hinged lid stays also have click-stop mechanism fixing the lid of the case at a 90° angle when lifted. The complete hinge array gives the lid and the case a more professional feel and look.





85 inch Microsoft Hub Screen Ovation Road Case Features:

- 9mm Plywood which is made up of Scandinavian Birch layers glued together with DIN-certified (DIN EN 204) D4 graded glue for maximum stability and resistance to moisture exposure. The ply is also protected by ABS coating on both sides with one side being textured for a more professional unique look and feel.
- Designed to house 1 x 85" Microsoft Hub Screen and carry stand
- Custom precision CNC routed insert for screen and stand support
- 12 x Large Cranked Butterfly Latches
- 12 x Large Recessed Sprung Handles
- 6 x Heavy Duty Adam Hall 100mmØ Castors with 2 x brake castors included
- 178x127mm Road Case Tour Label Dish

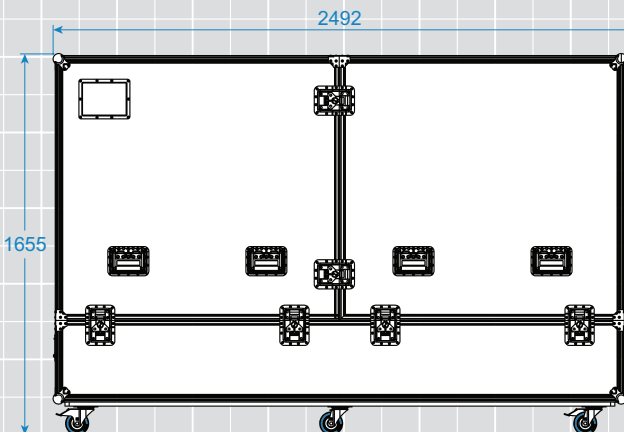

FRONT VIEW

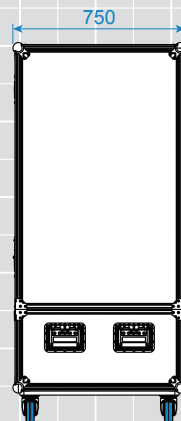

SIDE VIEW

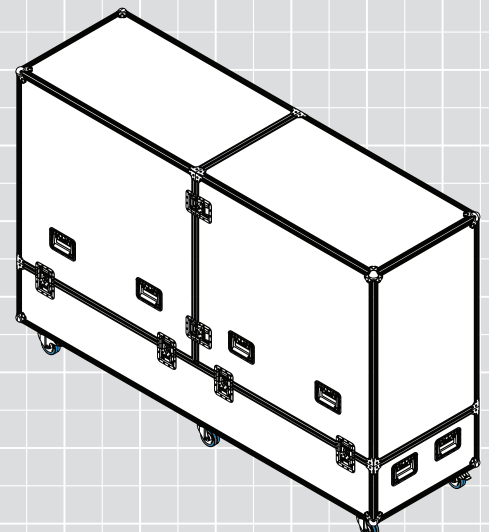

Why choose Ovation Cases?

From medical equipment, drones, engineering measurement equipment, cameras, coffee machines, merchandise stands, there will always be a need for a specially designed case to suit your specifications.

- Completely customisable solutions, inside and out, using 3D scanning technology and experienced team behind the scenes to help you select the best case style and specifications that will ensure complete protection for your valuable equipment.
- Built with high grade European quality materials and hardware ensuring peace of mind when it comes to case construction for safe transport capability.
- Faster turnaround time
- Australian designed & manufactured



PROUDLY
AUSTRALIAN DESIGNED & MANUFACTURED



WE'VE GOT *your* BACK

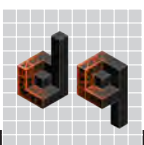

DQ.COM.AU

DESIGN QUINTESSENCE | SYD (02) 9649 2266 • MELB (03) 9645 2266 • BRIS 0419 777 877 • PER 0419 898 999 | EMAIL INFO@DQ.COM.AU